

version .0

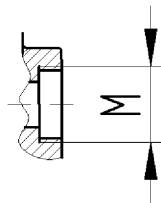
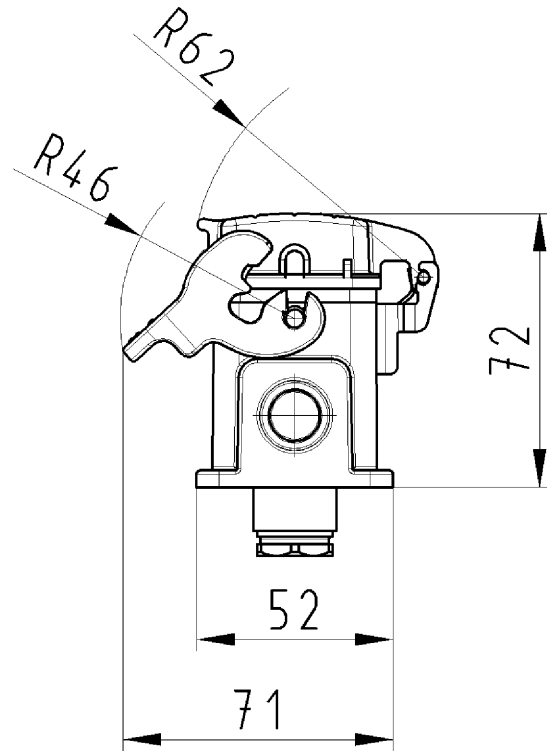
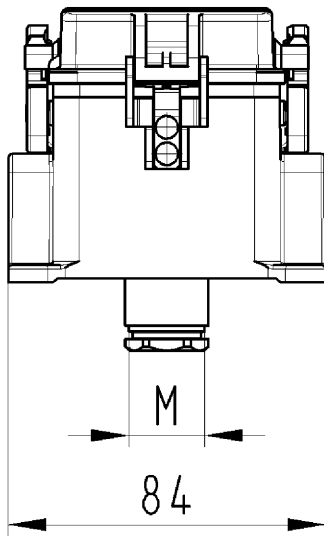

version .1

Gehäuseunterteil
70.343.0635.0
72.343.0635.0

Zeichnungsnummer
70.343.0635.010W
Gehäuseunterteil

20.11.2007
Schreiber Patrick
M 1:2